

# Tiling layout

A1	A2	A3	A4
B1	B2	B3	B4
C1	C2	C3	C4
D1	D2	D3	D4
E1	E2	E3	E4
F1	F2	F3	F4
G1	G2	G3	G4
H1	H2	H3	H4
I1	I2	I3	I4
J1	J2	J3	J4
K1	K2	K3	K4
L1	L2	L3	L4
M1	M2	M3	M4

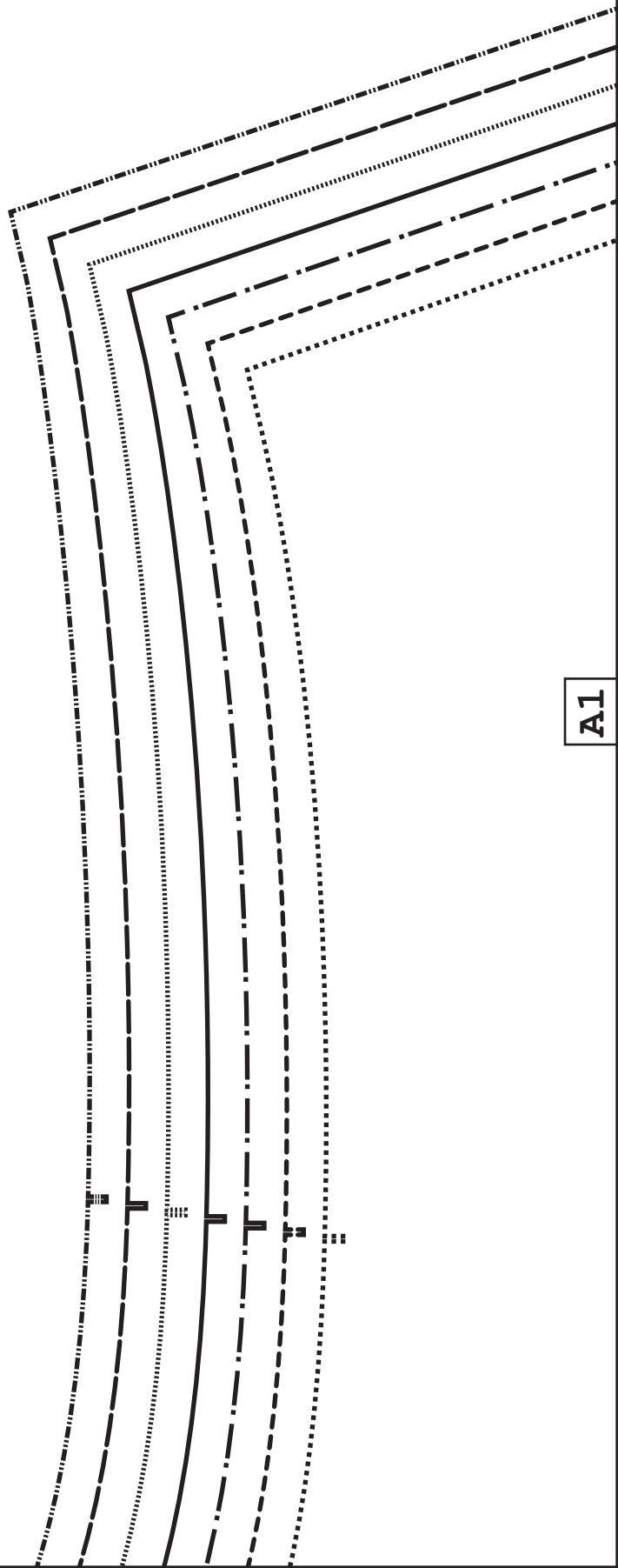

A1

A1

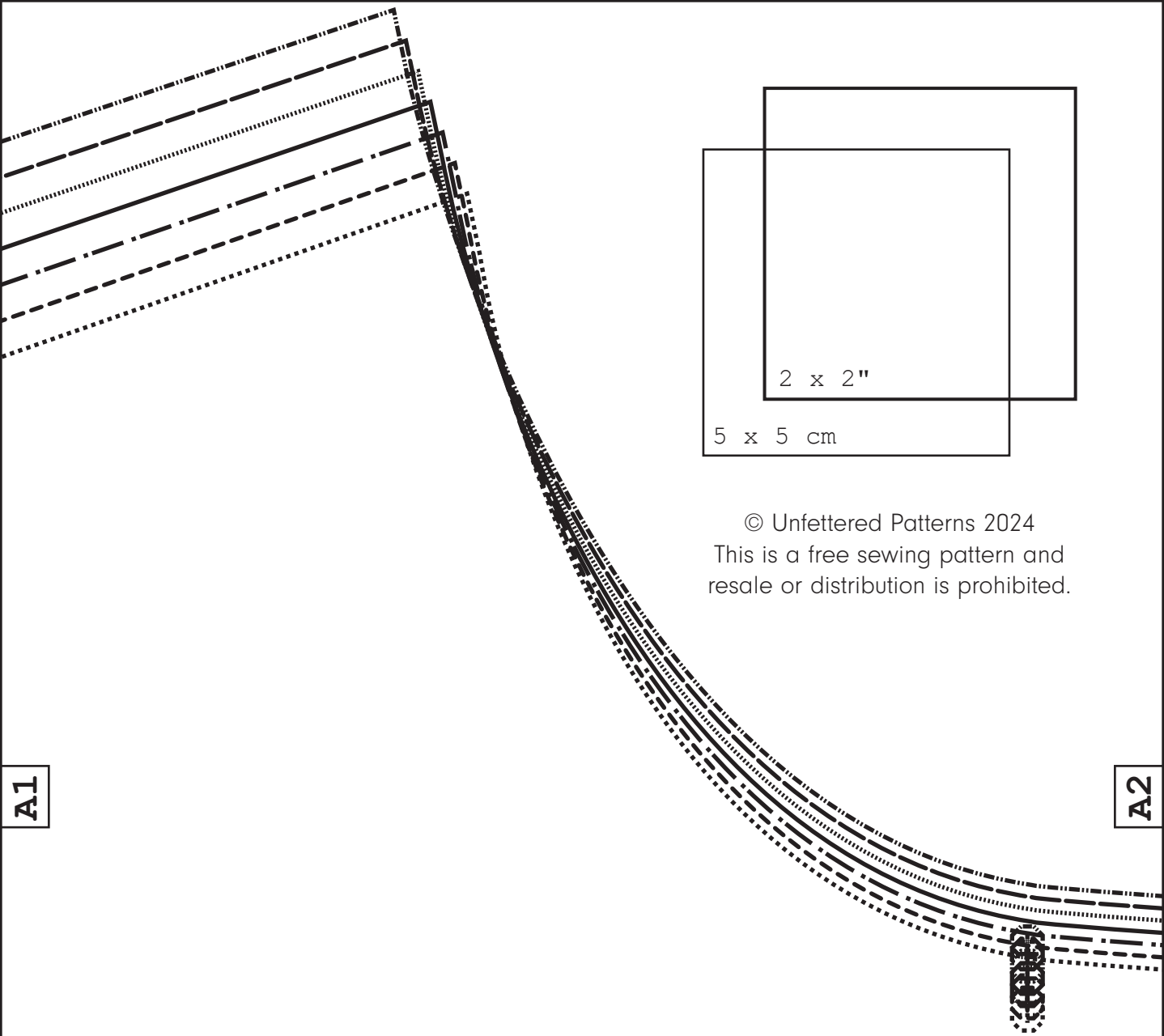

2 x 2"

5 x 5 cm

© Unfettered Patterns 2024  
This is a free sewing pattern and  
resale or distribution is prohibited.

A1

A2

A2

A2

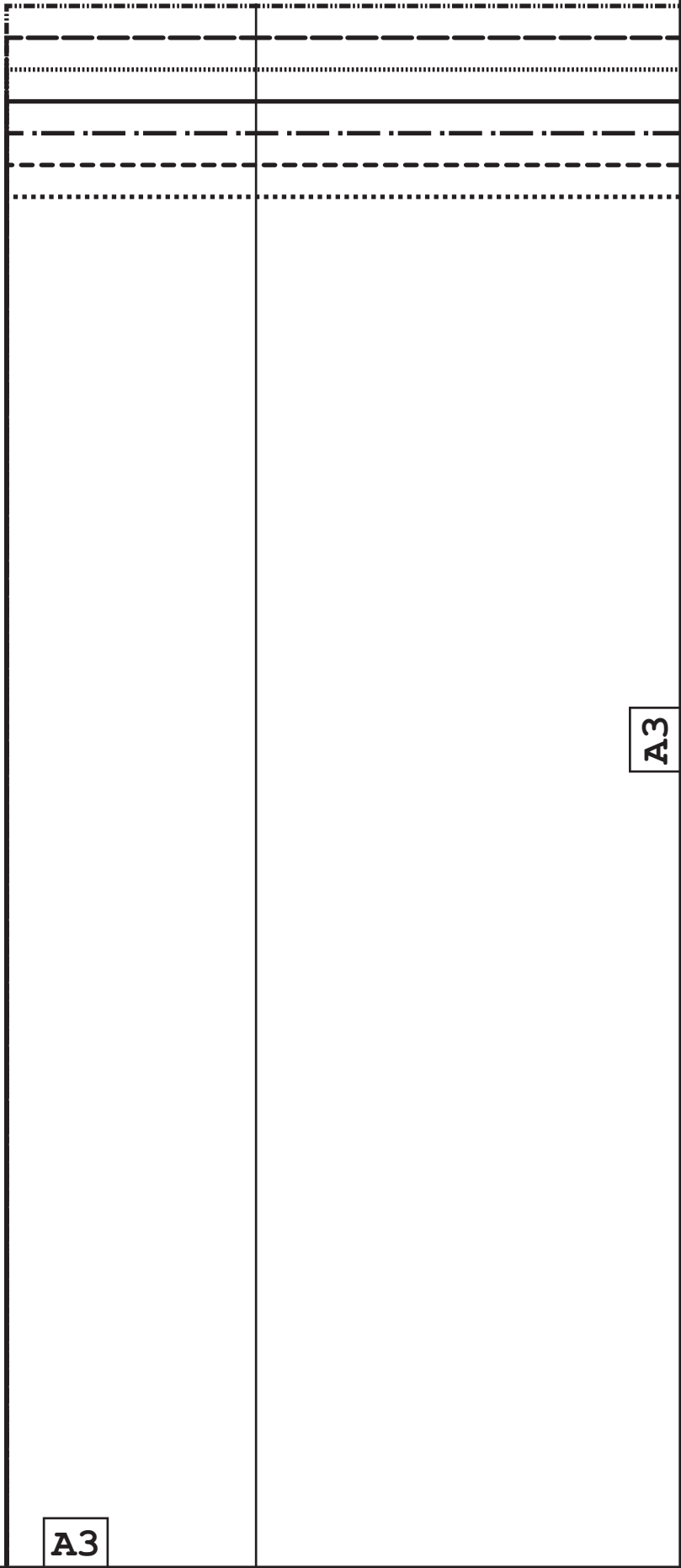
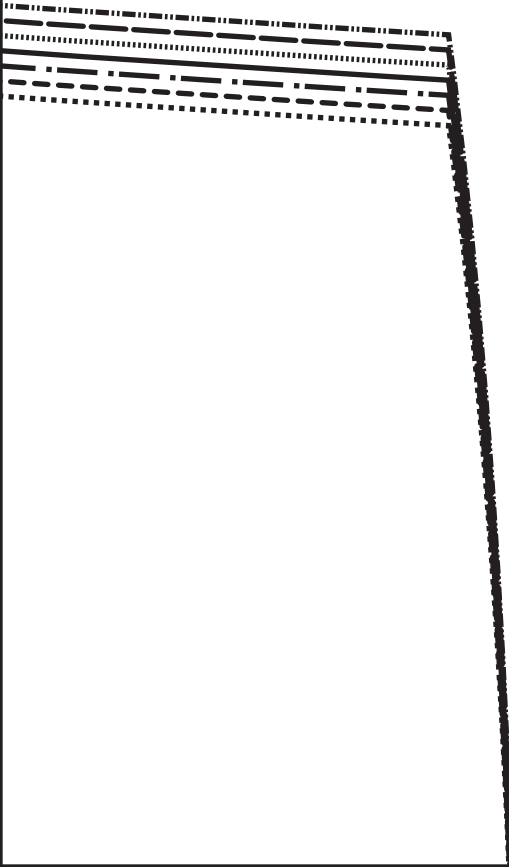

A3

A3

A3

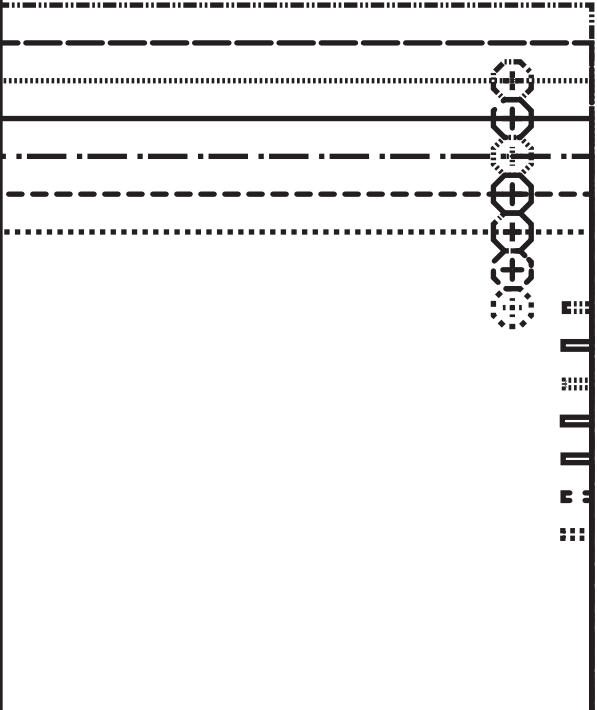

A4

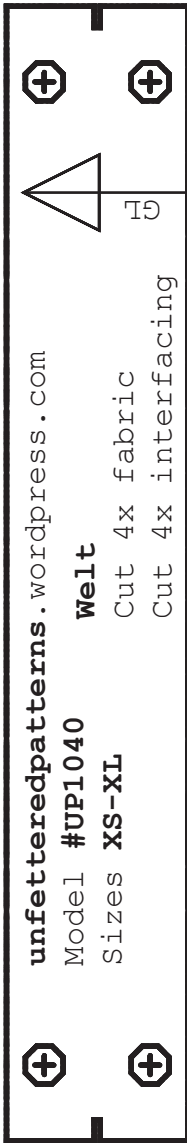
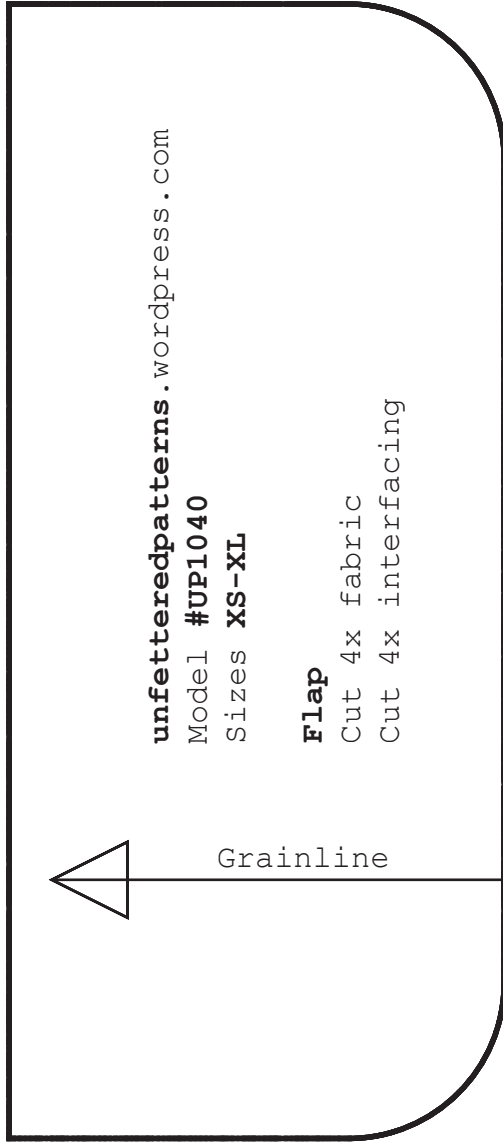

A1

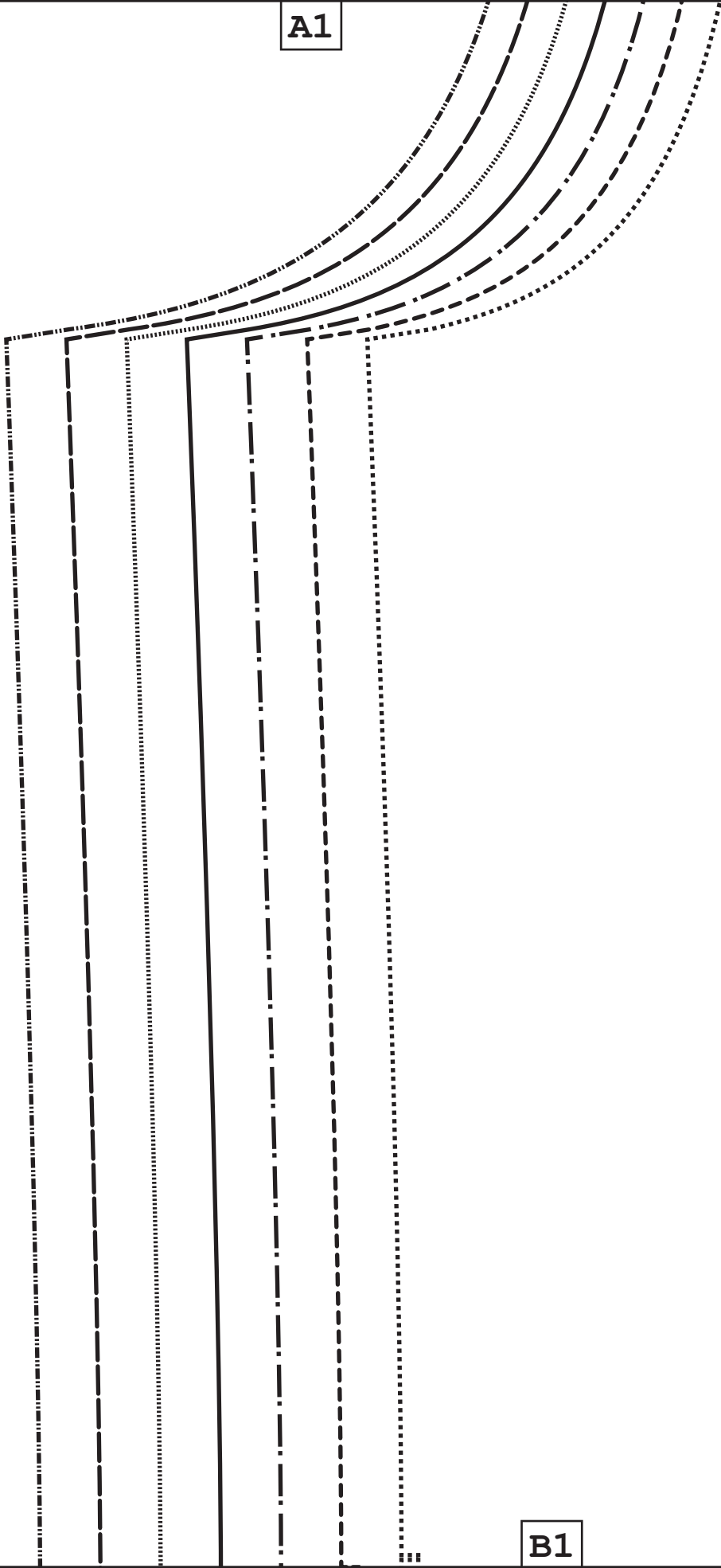

B1

B1

A2



B1

B2

*unfettered*  
— unfettered patterns —

[unfetteredpatterns.wordpress.com](http://unfetteredpatterns.wordpress.com)

Model #UP1040

Sizes XS-XL

**Front**

Cut 2x fabric

B2



e

wordpress.com  
Model #UP1040  
Sizes XS-XL  
Front facing  
Cut 2x fabric  
Cut 2x lining

— unfettered patterns —  
*attered*

B3

Grainline

A3

B3

B2

A4

unfettered patterns.

unfettered

B3

X

B4

B1

C1

C1

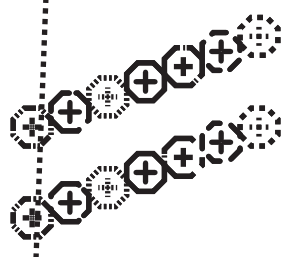

B2

Grainlin

C1

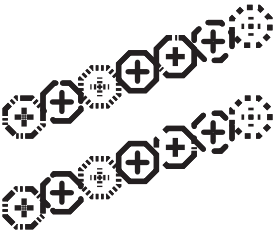

C2

C2

B3

C2



C3



C3

B4



C3

C4

C1

SIZE KEY

XL	-----
L	-----
M/L	-----
M	-----
S/M	-----
S	-----
XS	-----

D1

Hem allowance  
4 cm (1 1/2")

D1

C2



D1

D2

ce  
)

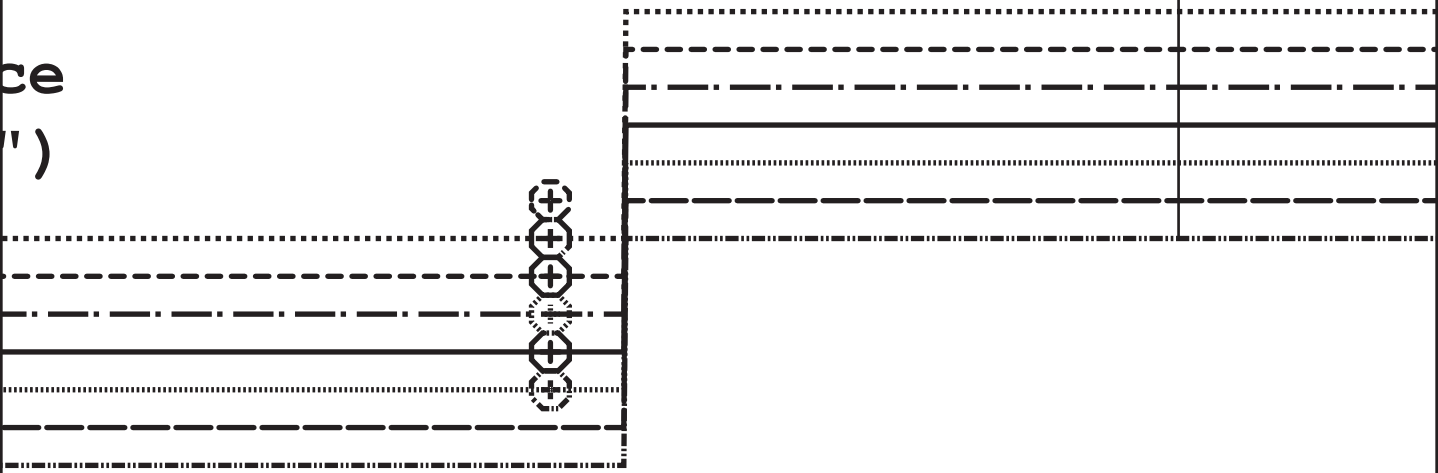

D2

C3



D2

D3

D3

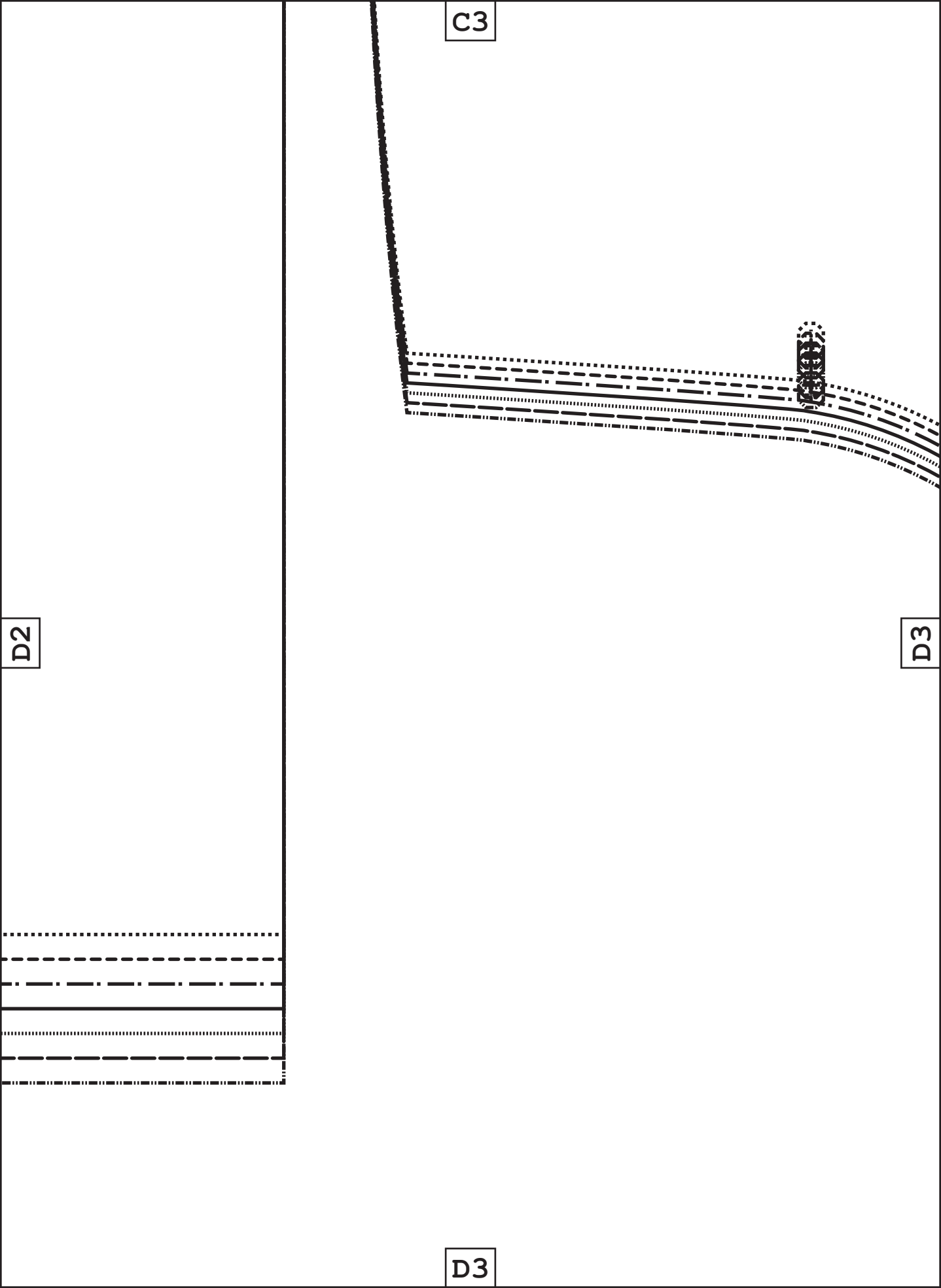

C4

D3

D4

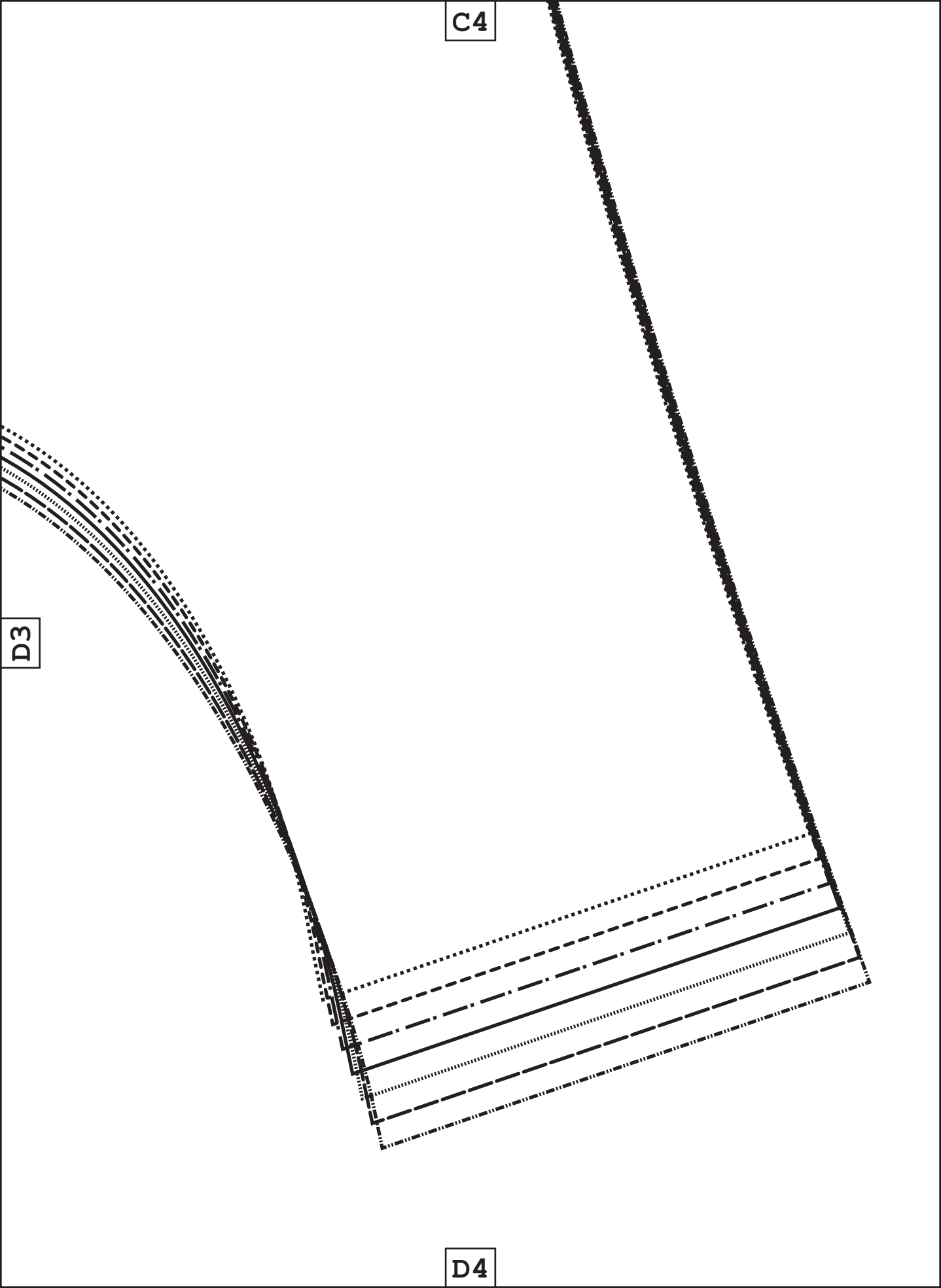

D1

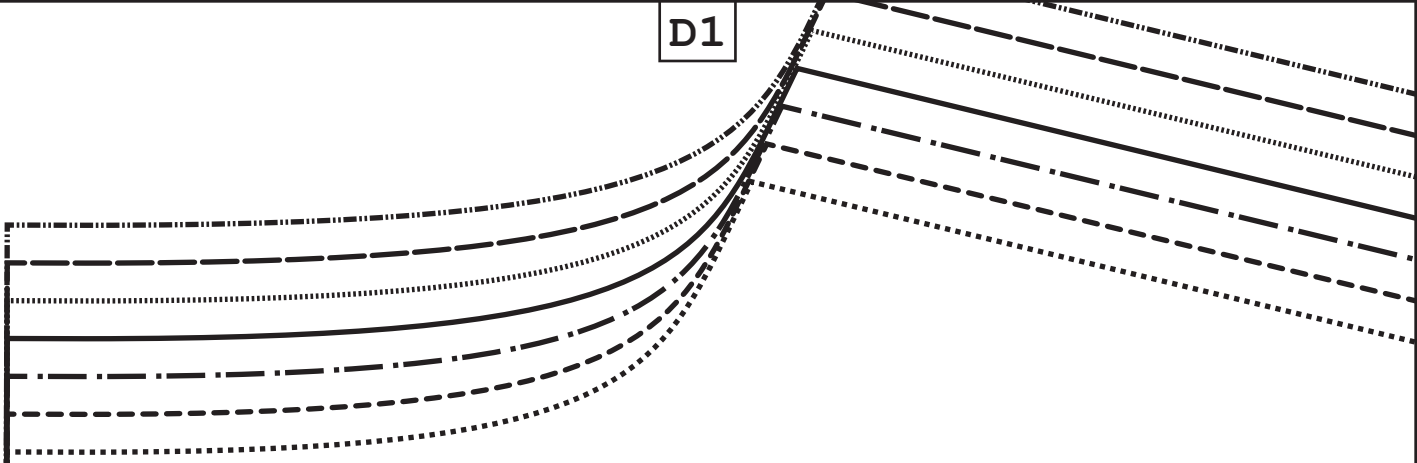

E1



E1

D2

E1

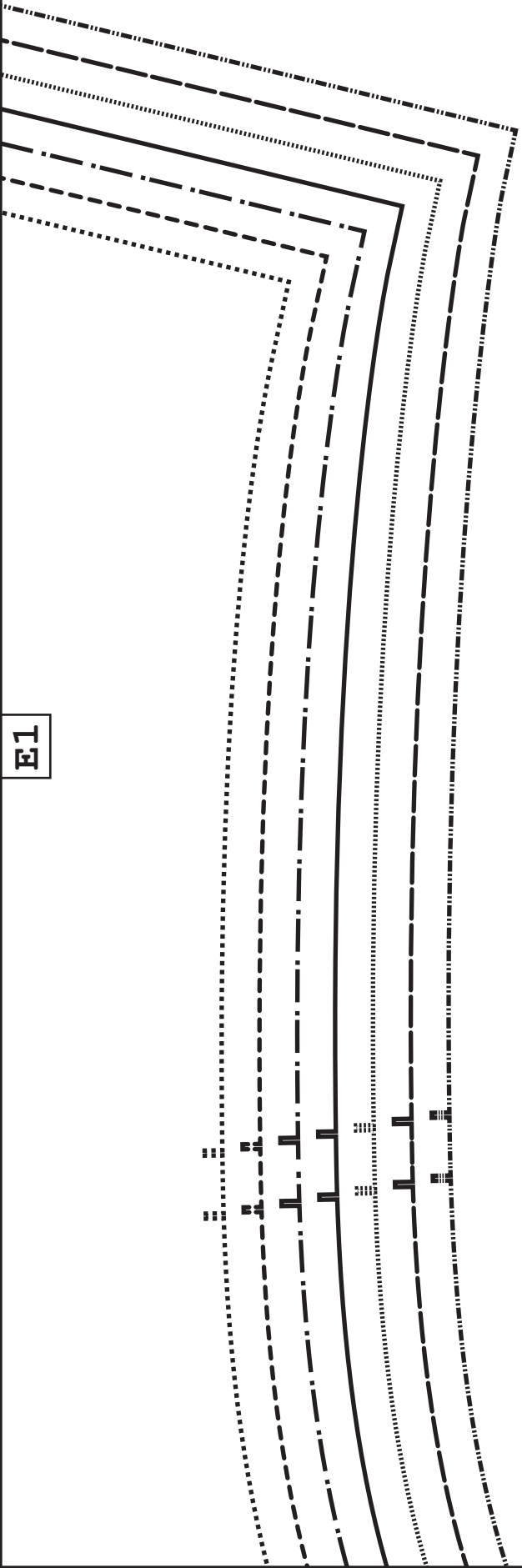

E2

E2



D3

E2

E3

E3

SIZE KEY

- ..... SX
- S
- M/S
- \_\_\_\_\_ M
- ..... T/M
- T
- ..... XL

D4

E3

E4

E1

E1

*unfettered*  
— unfettered patterns —

F1

E2

F2

F2

F1

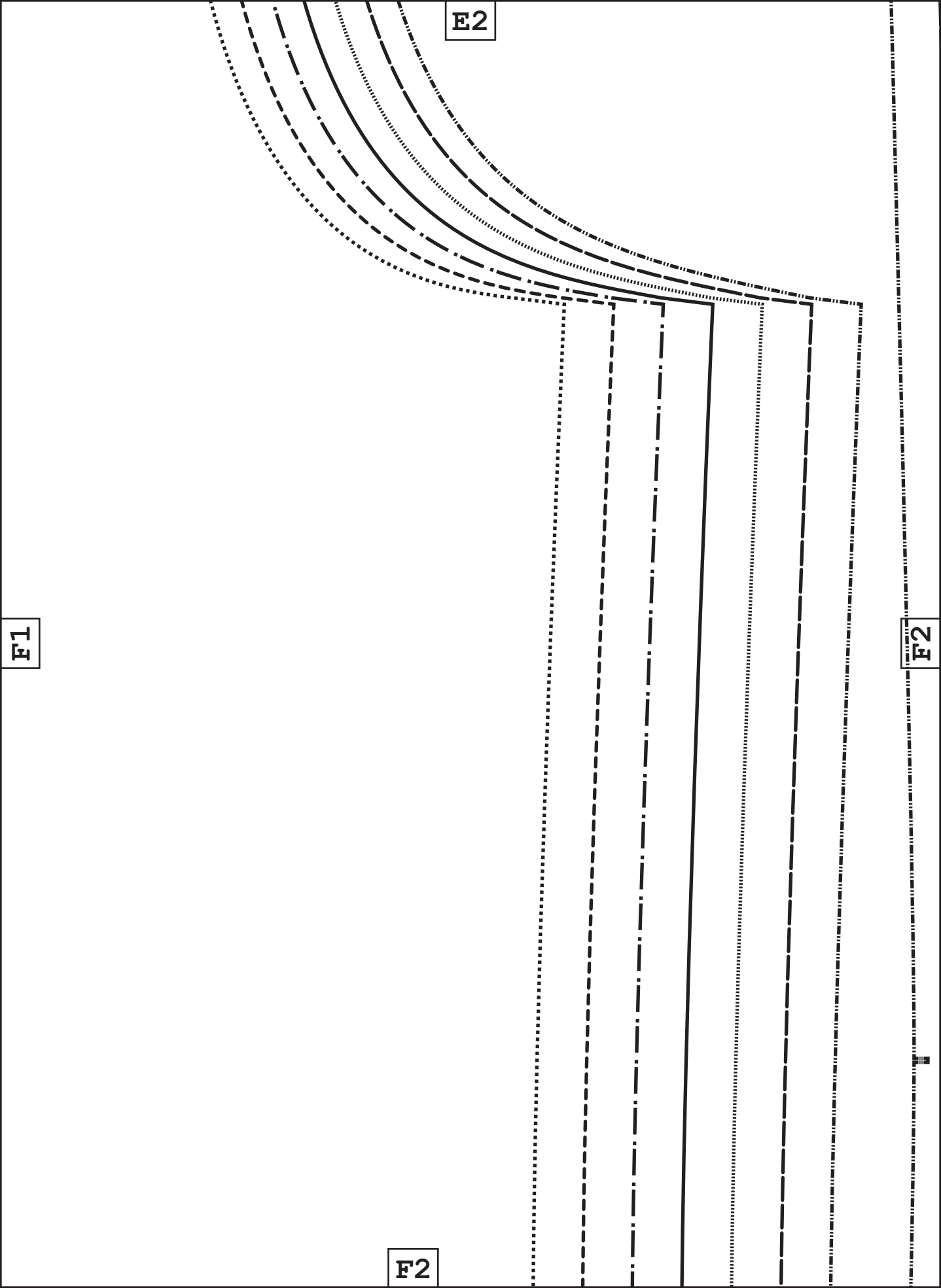

E3

F3

F3

F2

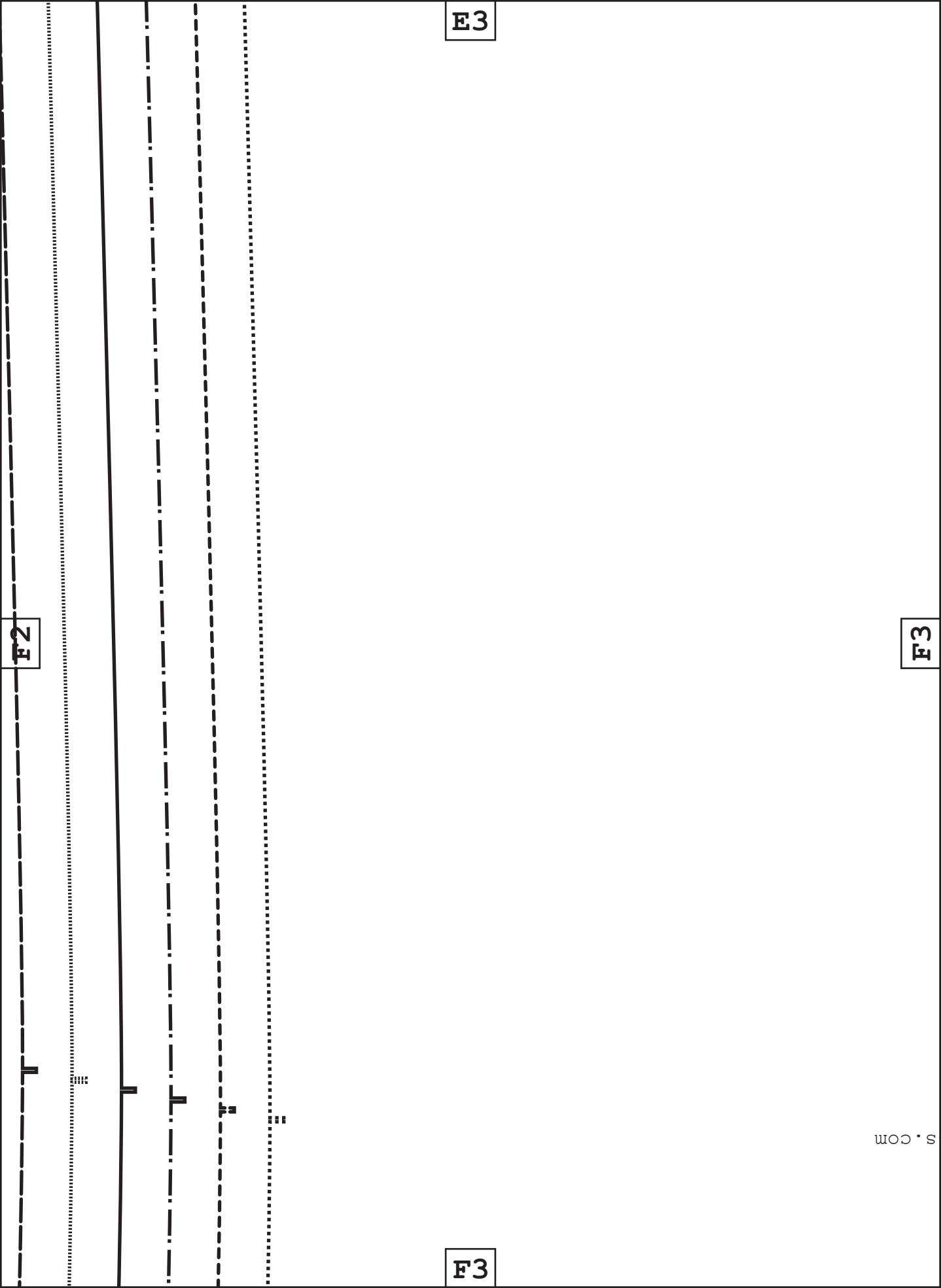

E4

Grainline

F4

F3

unfettered  
— unfettered patterns —

unfetteredpatterns.com  
Model #UP1040

Sizes XS-XL

Back Lining  
Cut 2x lining

**F1**

Model **#UP1040**

Sizes **XS-XL**

**Back**

Cut 2x fabric

Grainline

**G1**

**G1**

SIZE

...XL

F2

G1

G2

G2

LE KEY

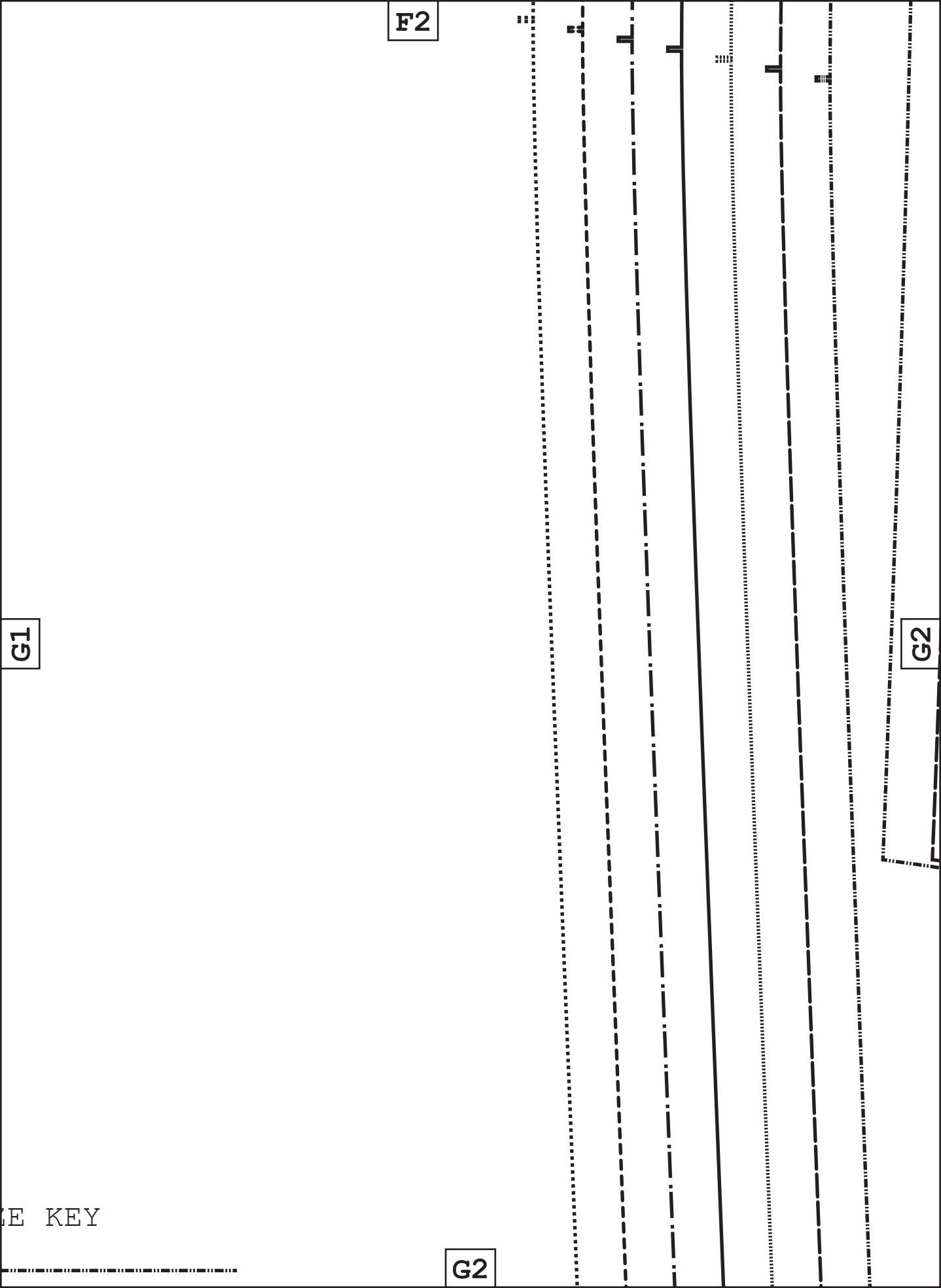

F3

G2

G3

G3

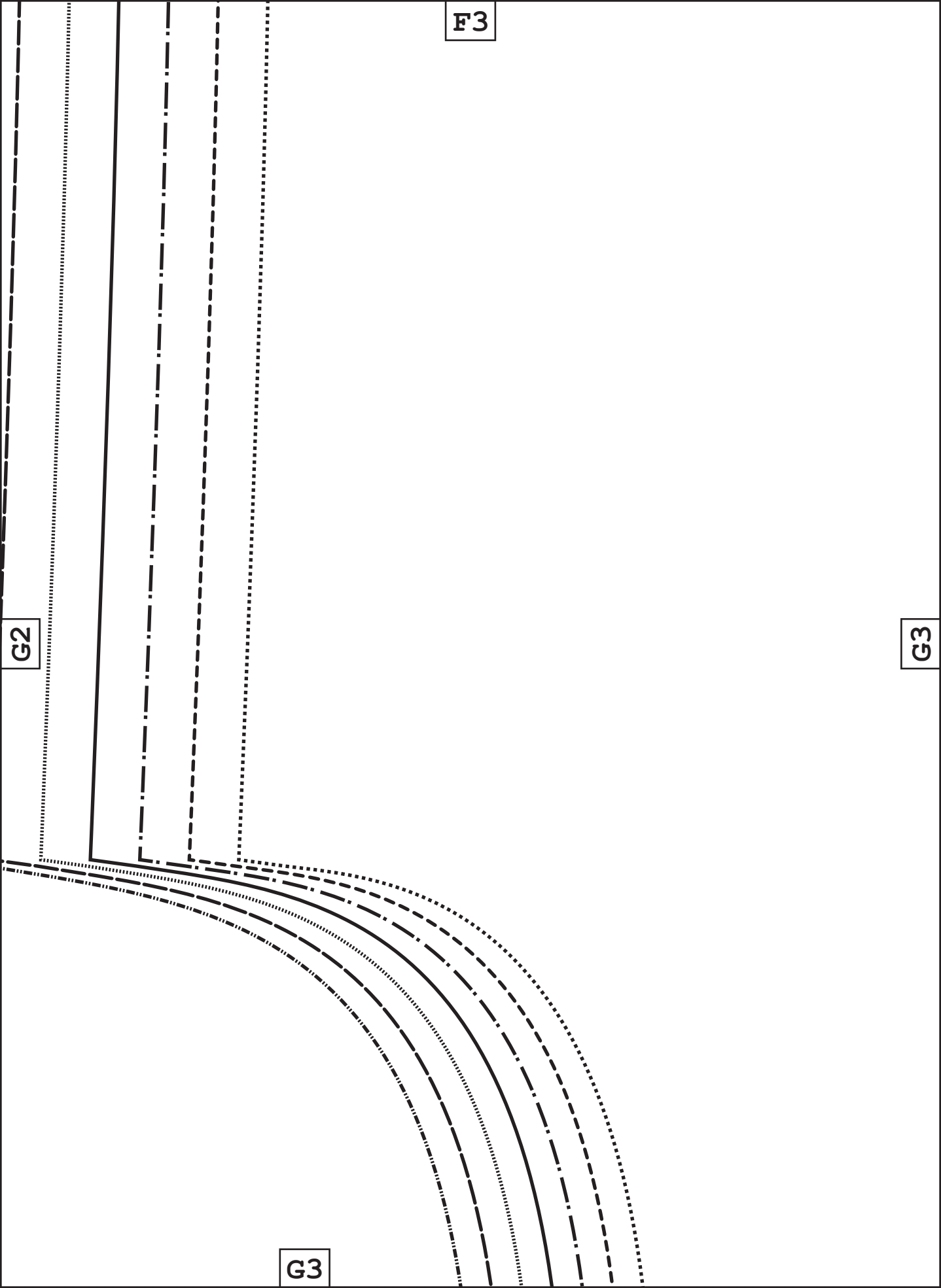

F4



G3

G4

back

G1

L  
M/  
M  
S/  
S  
XS

H1

Hem allow  
4 cm (1 1

H1

G2

H1

H2

H2

rance  
(/2")

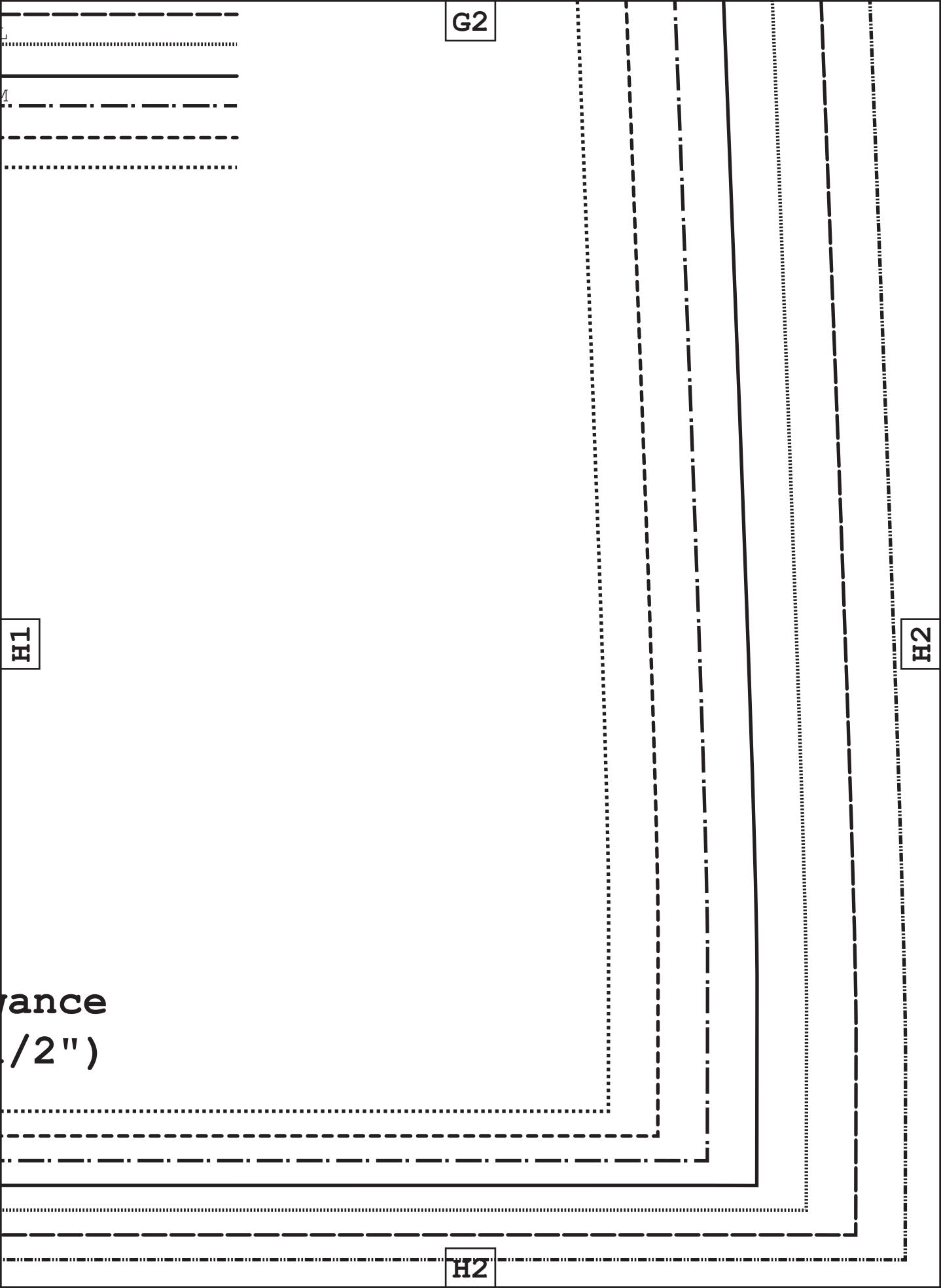

G3

H2

H3

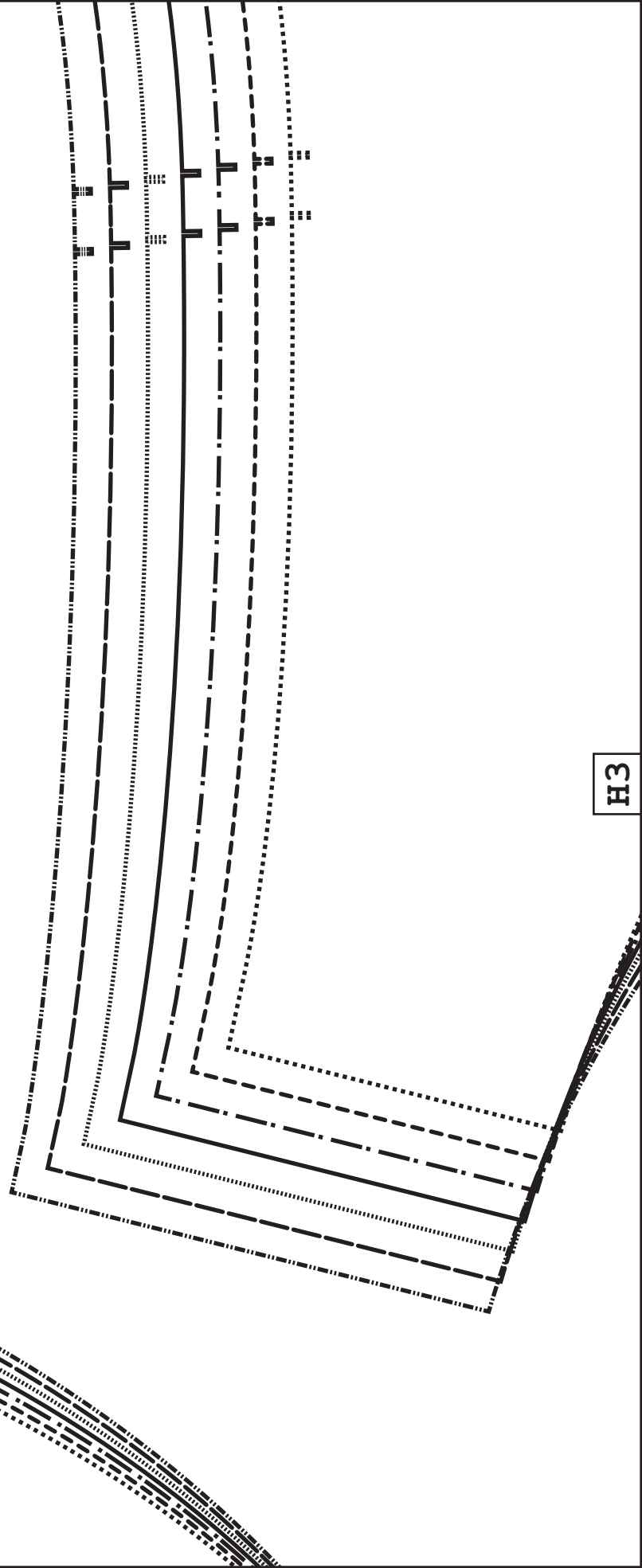

H3

G4

Center

H3

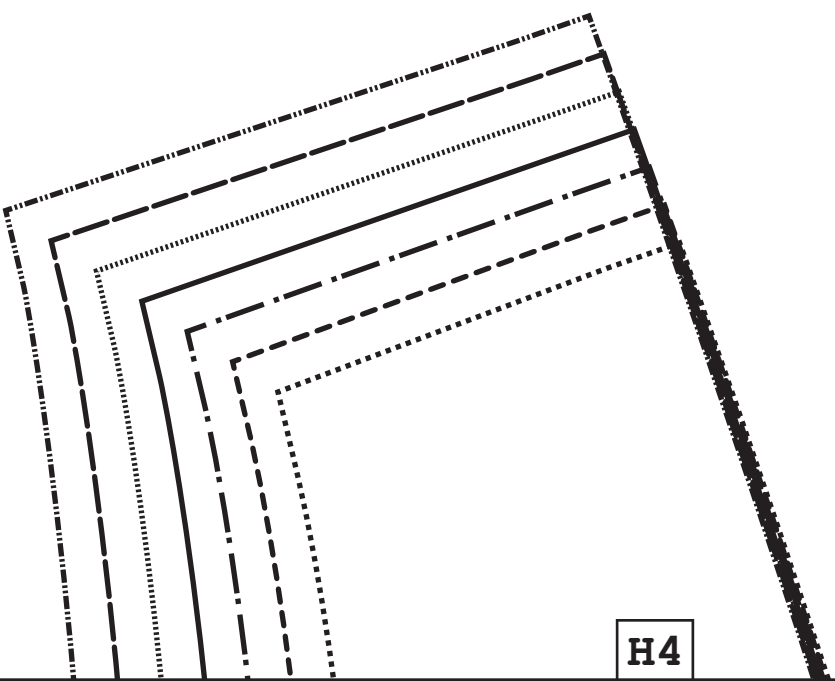
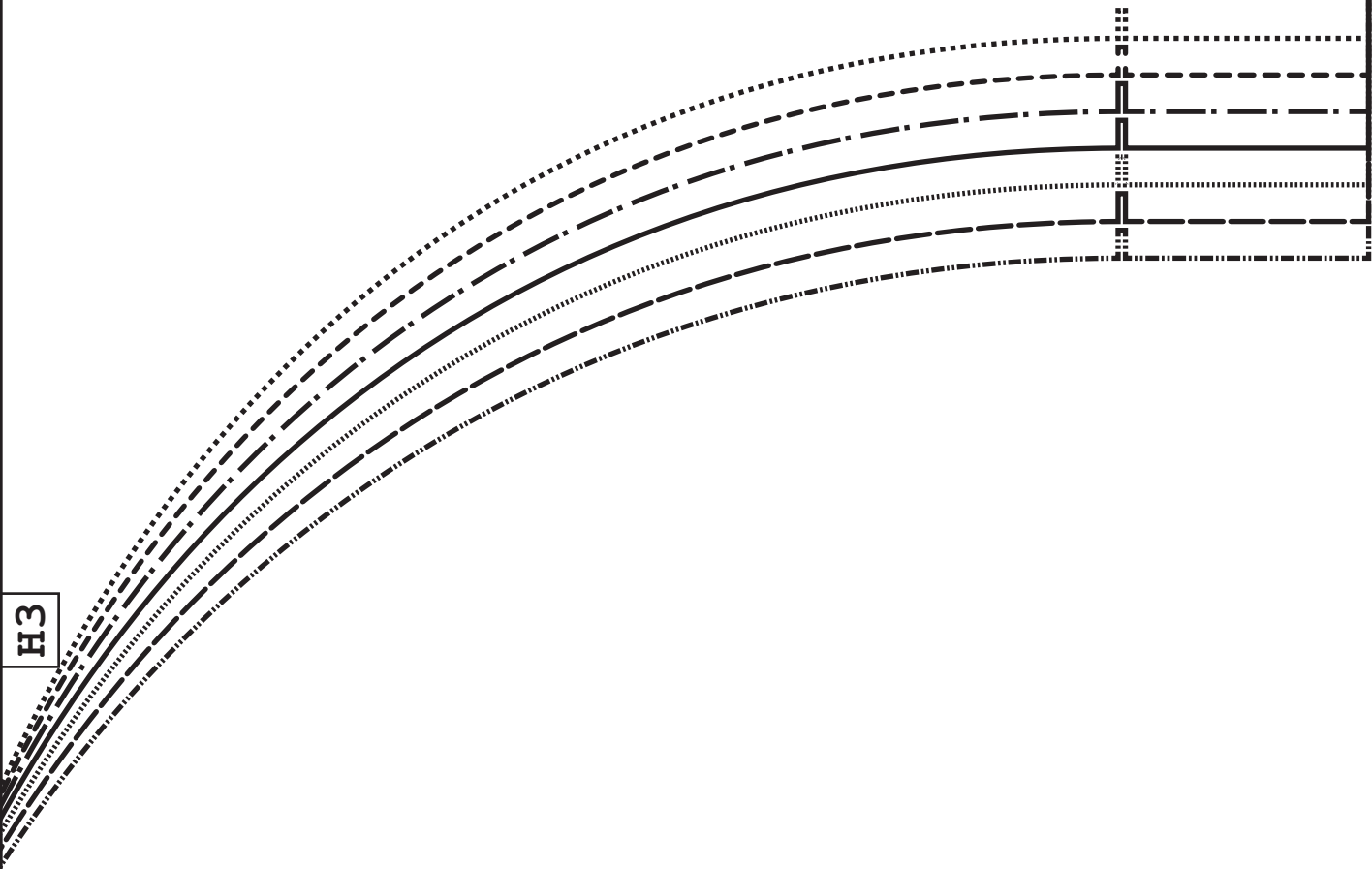

H4

H1

I1

I1

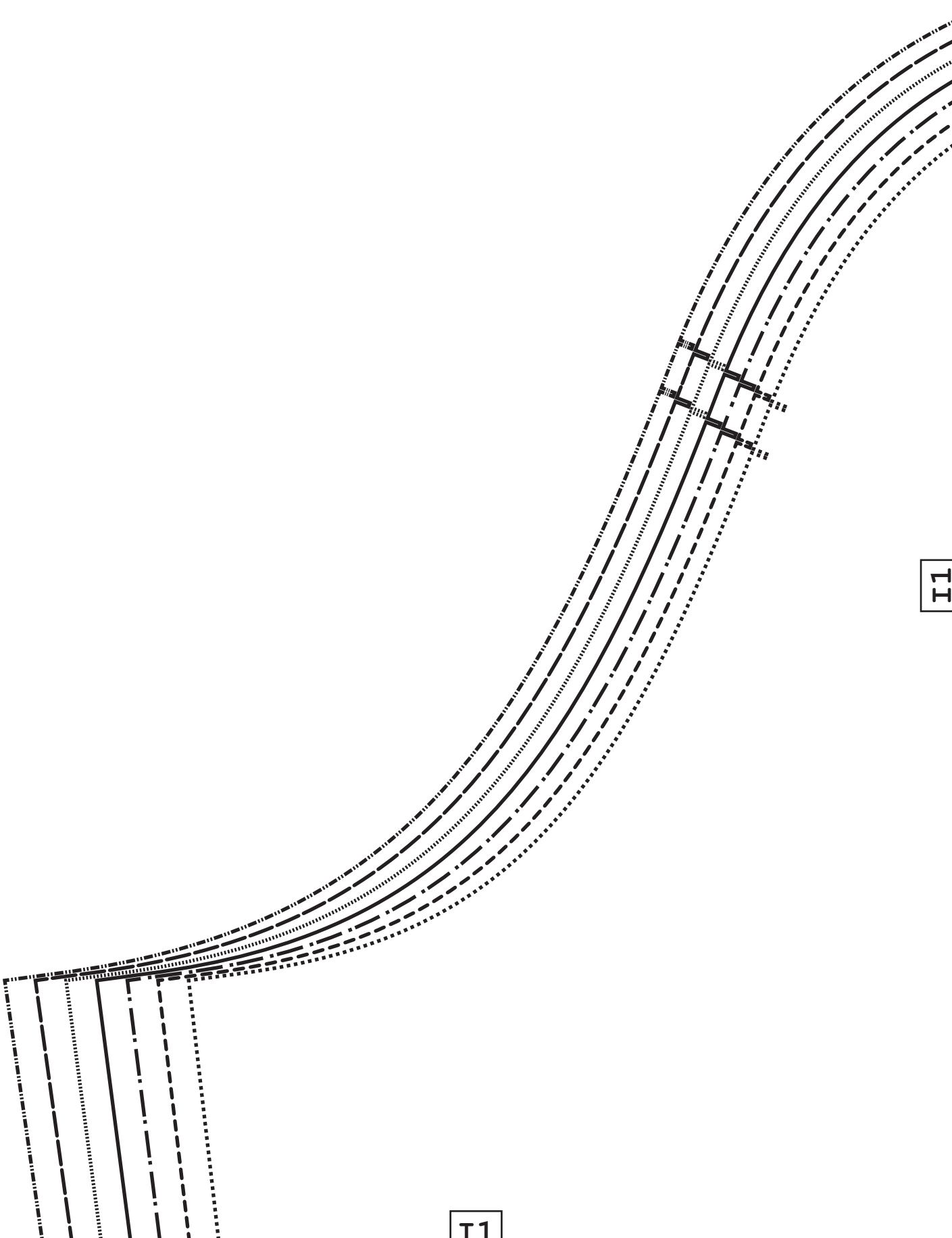

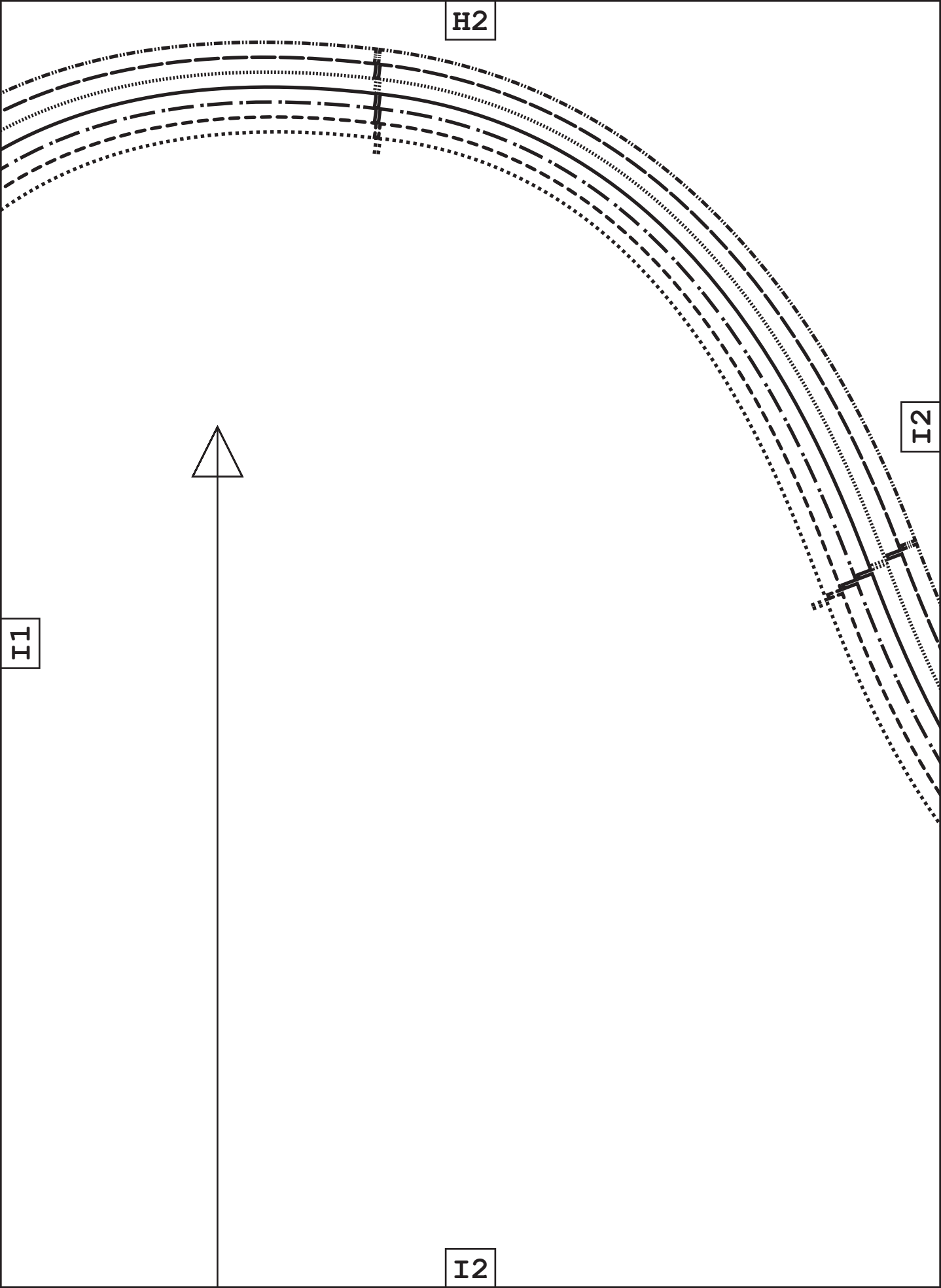

H3

# unfettered

— unfettered patterns —

[unfetteredpatterns.wordpress.com](http://unfetteredpatterns.wordpress.com)

Model #UP1040

Sizes XS-XL

**Back facing**

Cut 1x fabric

Cut 1x interfacing

I3

I2

Cut this edge  
on the fold of the fabric



I3

H4

I3

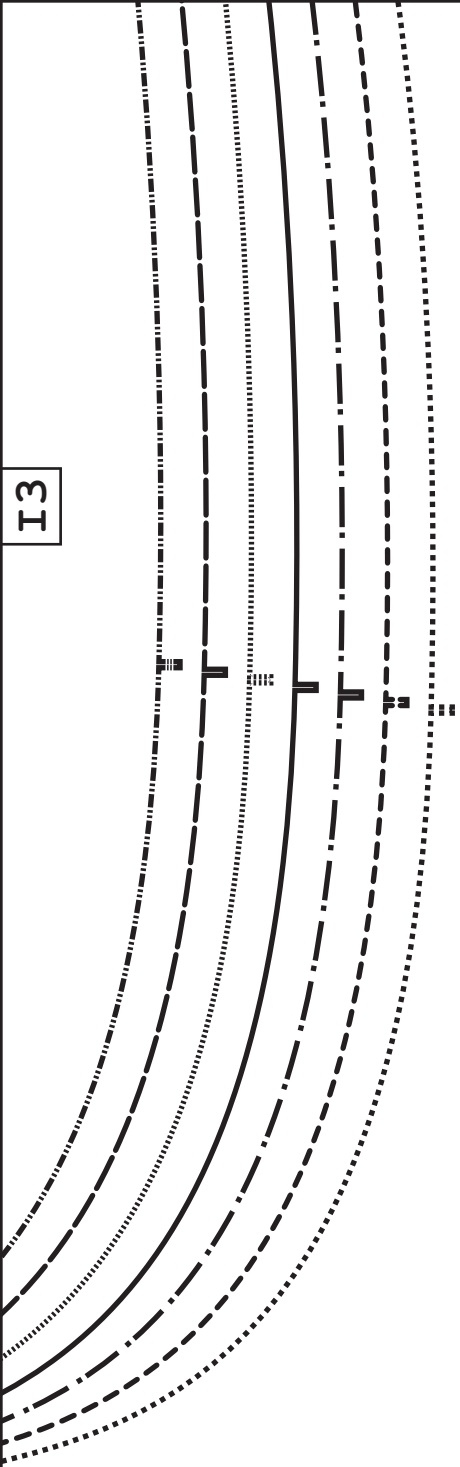

I4



I1

J1

### SIZE KEY

XL	.....
L	-----
M/L	.....
M	—————
S/M	-----
S	-----
XS	.....

J1

I2

*unfettered*  
— unfettered patterns —

[unfetteredpatterns.wordpress.com](http://unfetteredpatterns.wordpress.com)

Model **#UP1040**

Sizes **XS-XL**

**Sleeve lining**

Cut 2x lining

Grainline

J1

J2

J2



I4

J3

*unfettered*  
— unfettered patterns —

Grainline

J4

J1

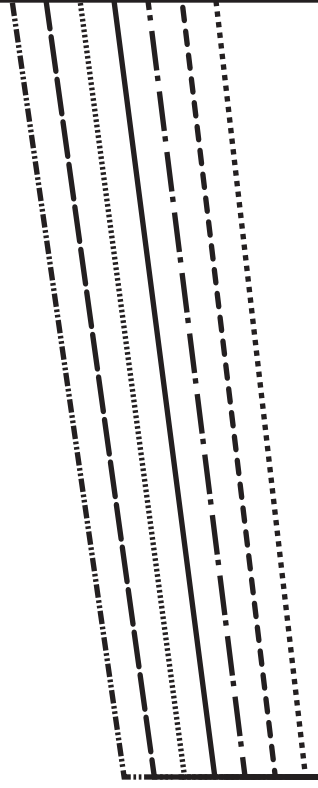

K1

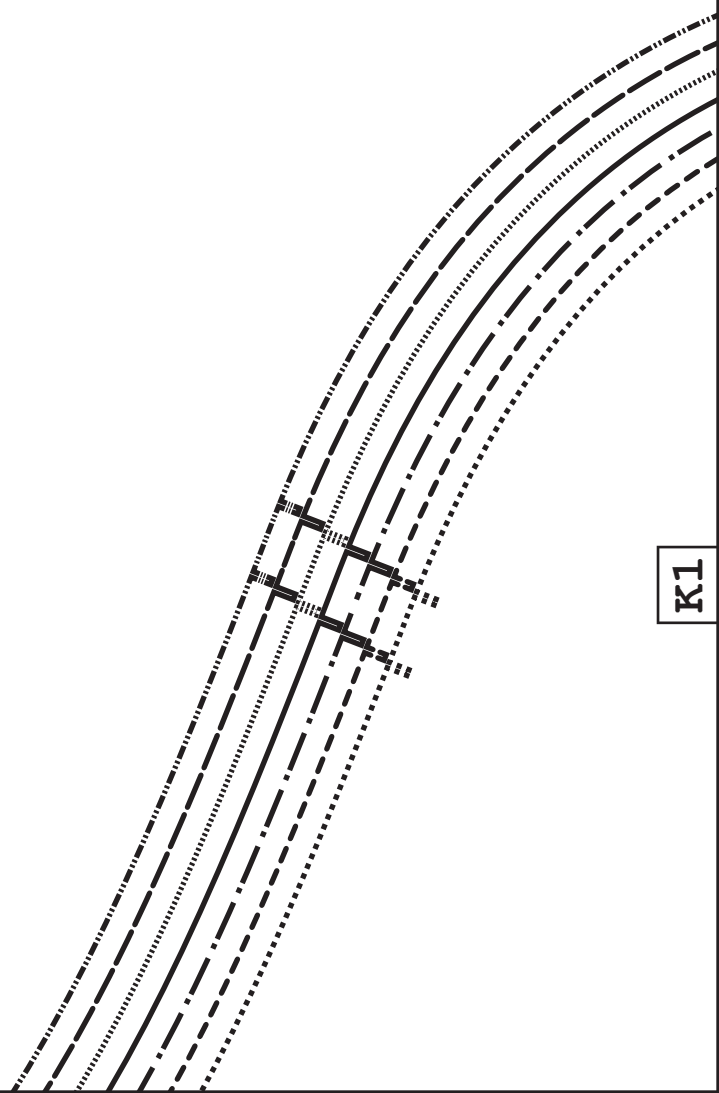

K1

J2

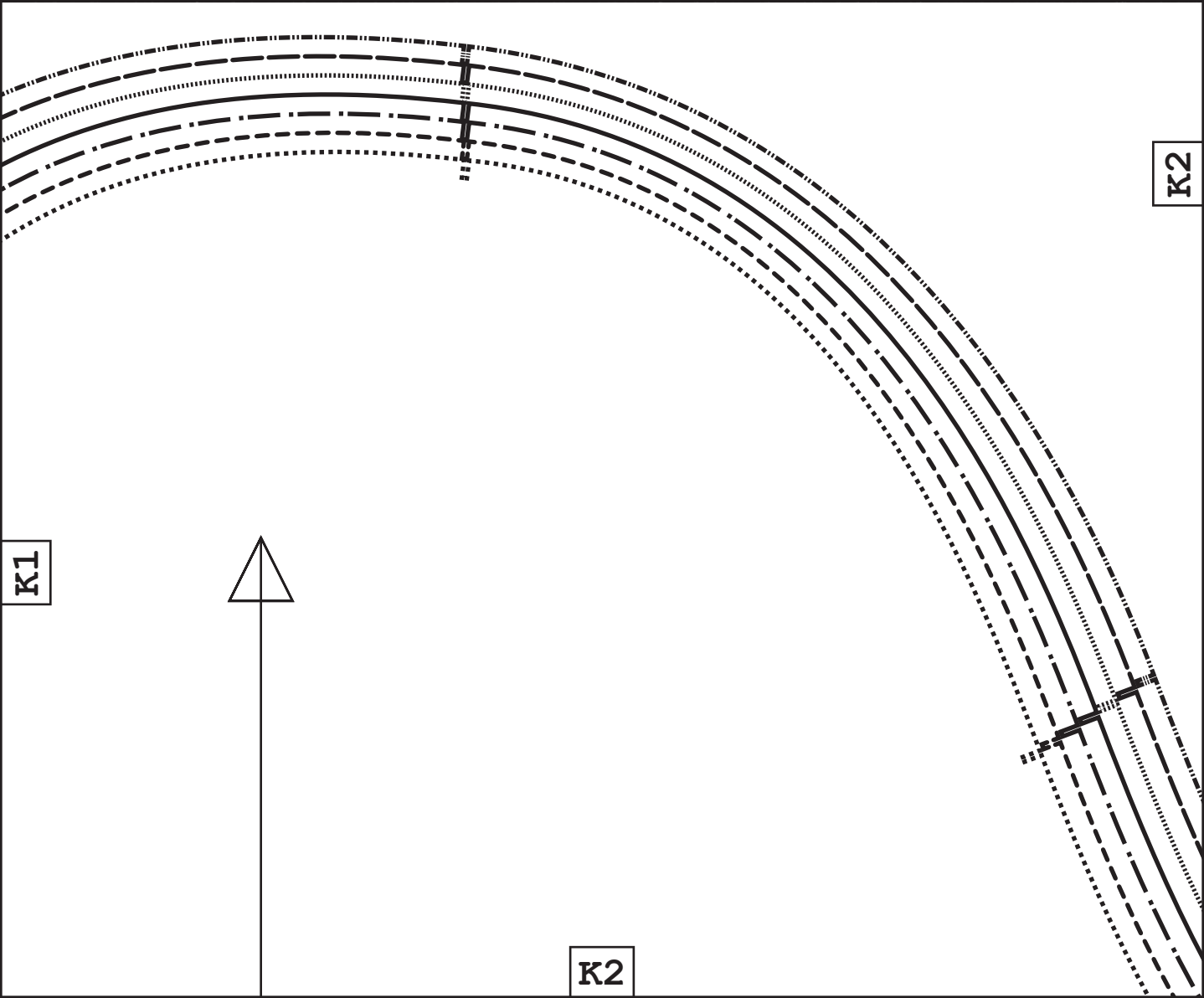

K1

K2

K2

J3

K2

K3

K3

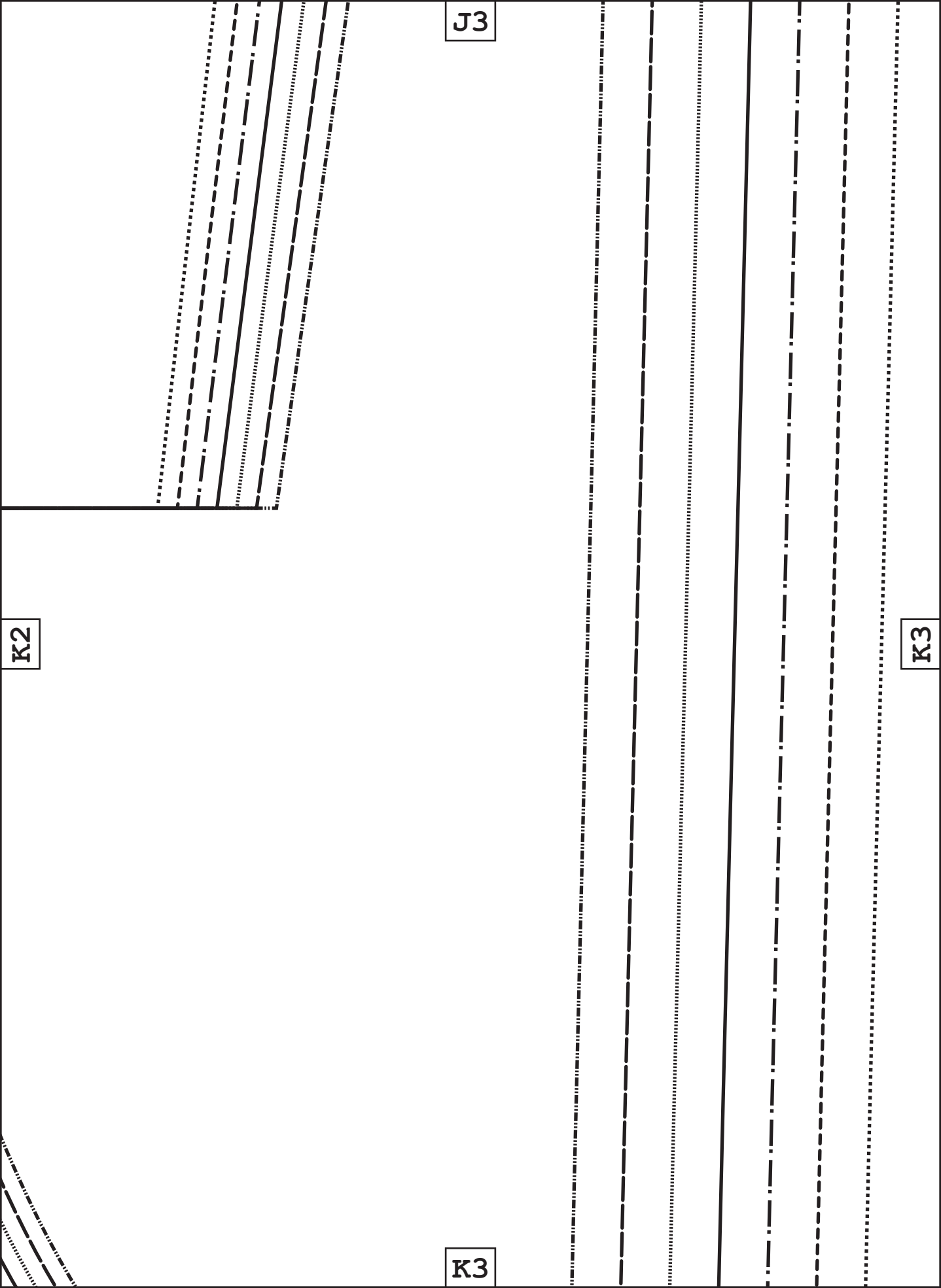

Model #UP1040 **J4**  
Sizes XS-XL

**Front lining**  
Cut 2x lining

**K3**

**K4**

K1

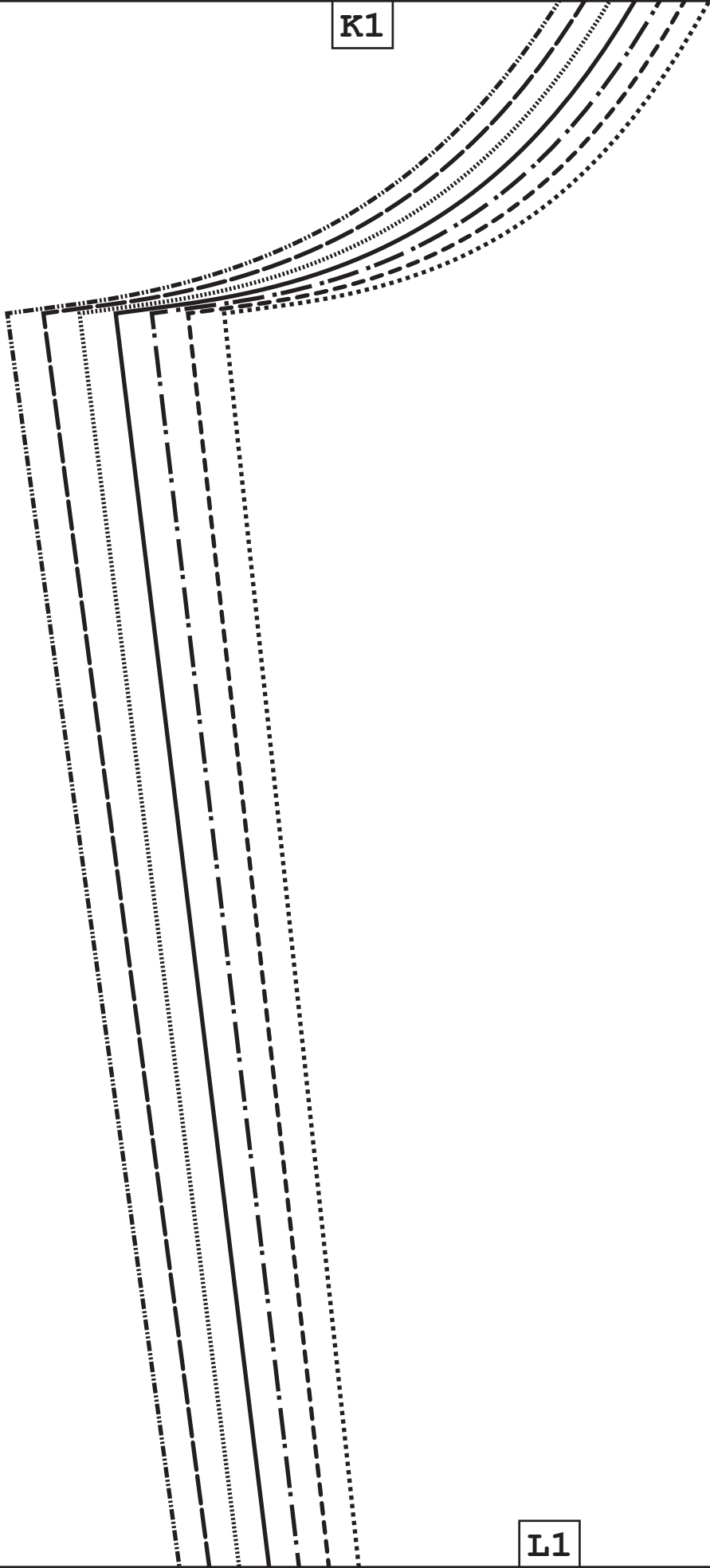

L1

SIZE KEY

L1

XL  
-----

K2

L1

*unfettered*  
— unfettered patterns —

[unfetteredpatterns.wordpress.com](http://unfetteredpatterns.wordpress.com)

Model #UP1040

Sizes XS-XL

**Sleeve**

Cut 2x fabric

Grainline

L2

K3

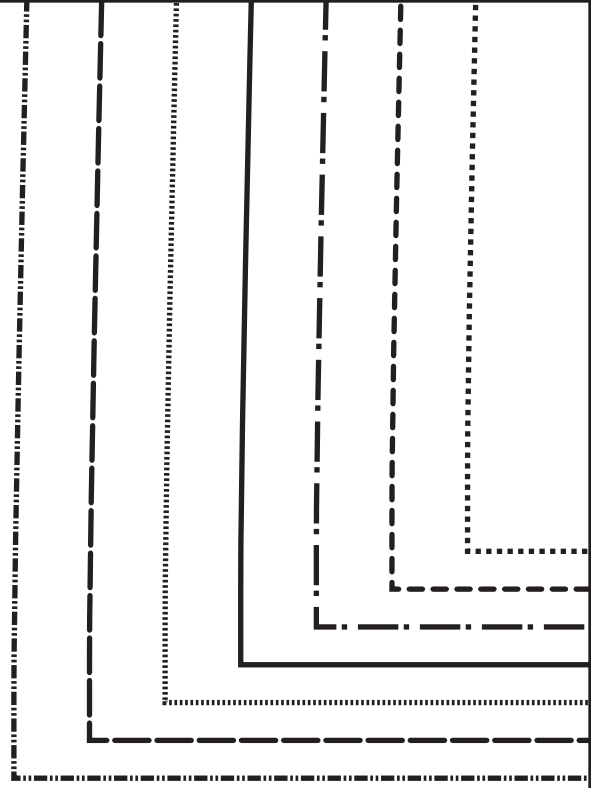
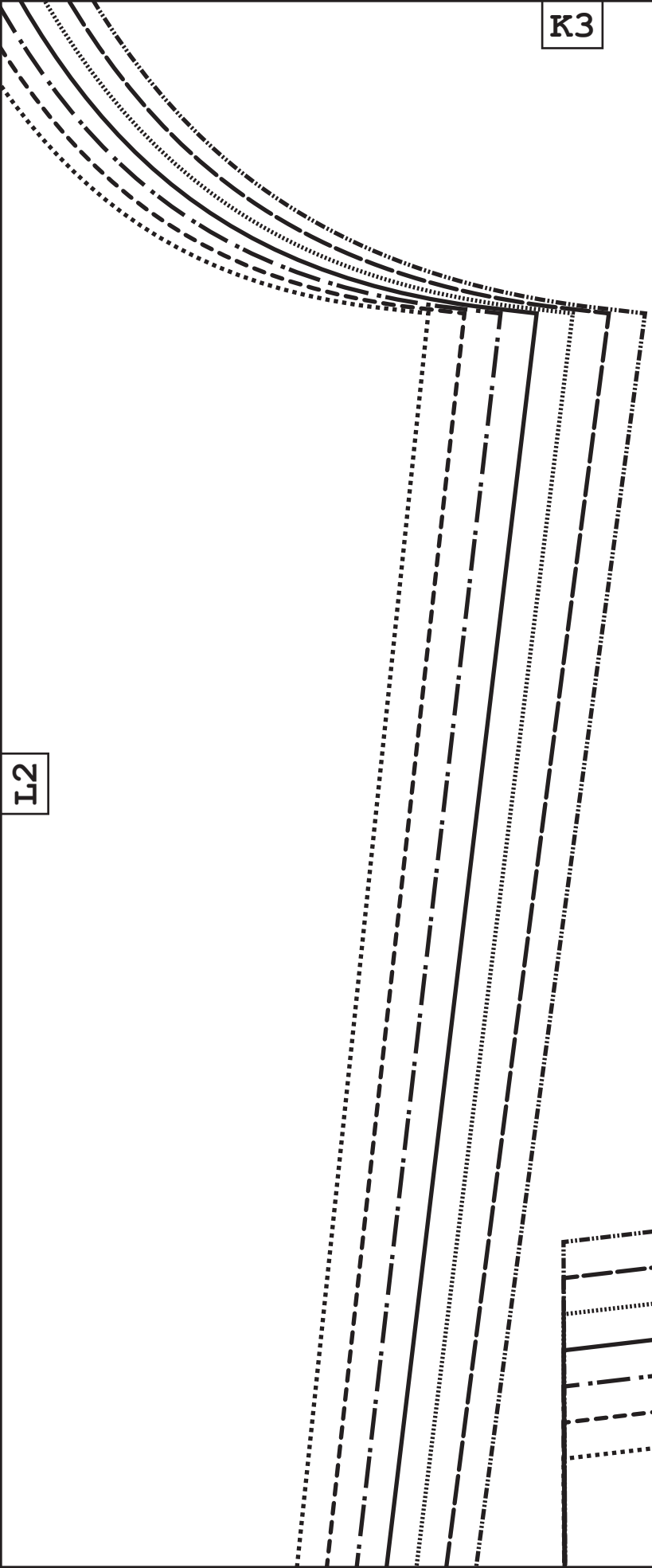

L2

L3

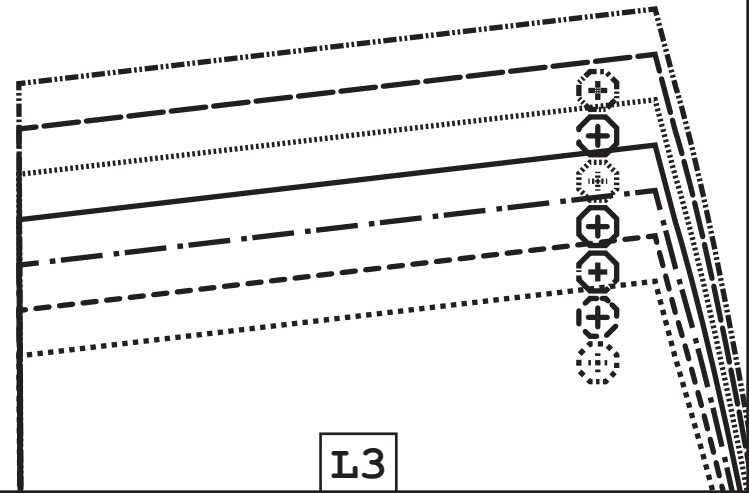

L3

K4

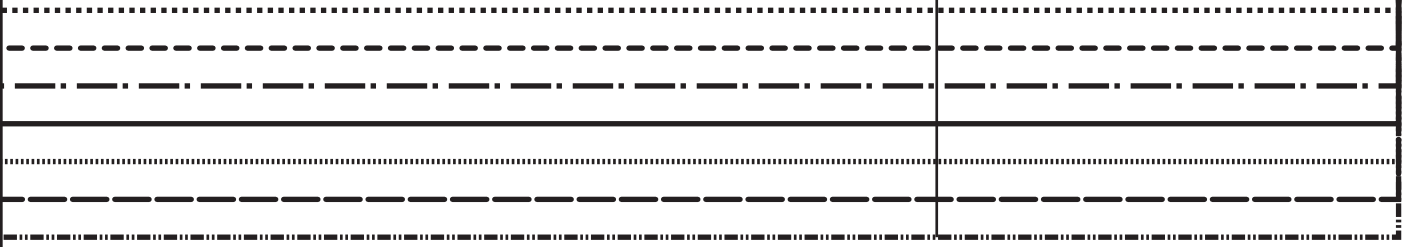

L3

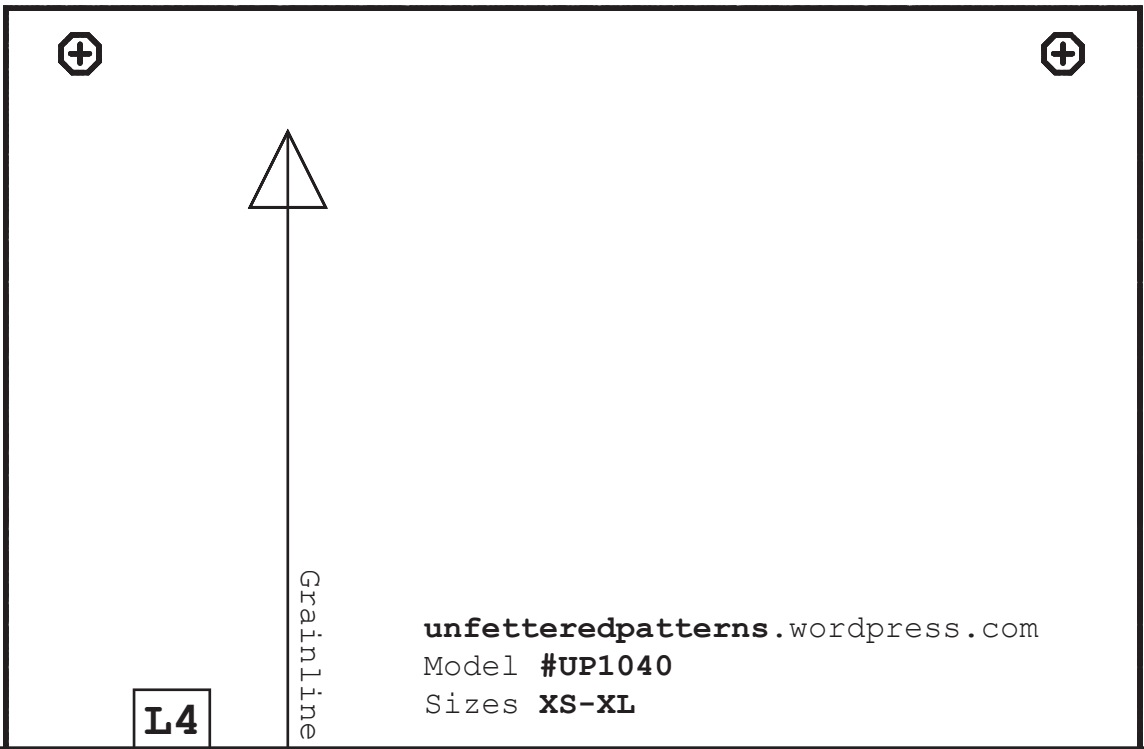

[unfetteredpatterns.wordpress.com](http://unfetteredpatterns.wordpress.com)

Model #UP1040

Sizes XS-XL

L4

L1

L

M/L

M

S/M

S

XS

M1

L2

M1

M2

Hem allowance  
4 cm (1 1/2")

M2

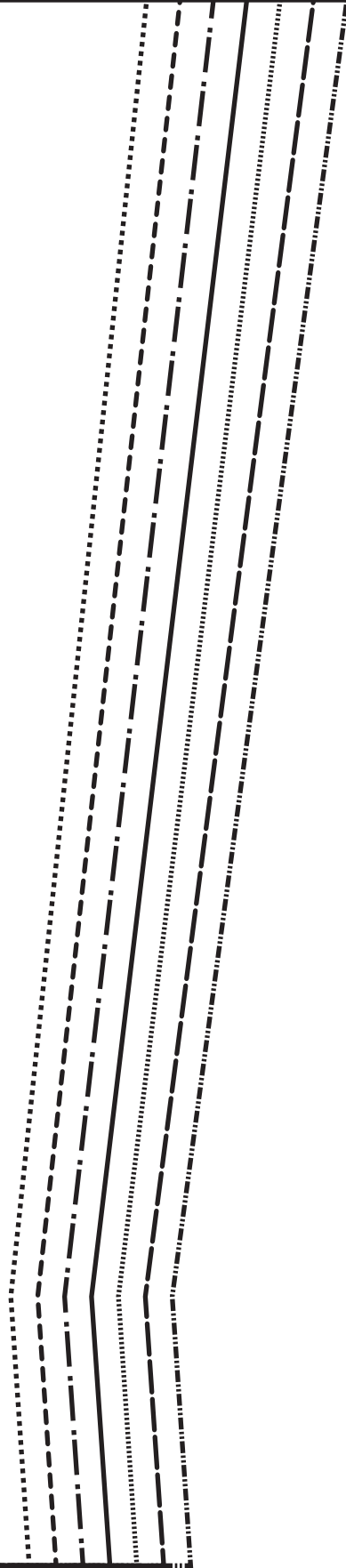

L3

— — — unfettered patterns —  
*unfettered*

[unfetteredpatterns.wordpress.com](http://unfetteredpatterns.wordpress.com)

Model #UP1040

Sizes XS-XL

**Collar**

Cut 2x fabric

Cut 2x interfacing

M3

Cut this edge  
 on the fold of the fabric



L4

Lower pocket lining

Cut 2x lining

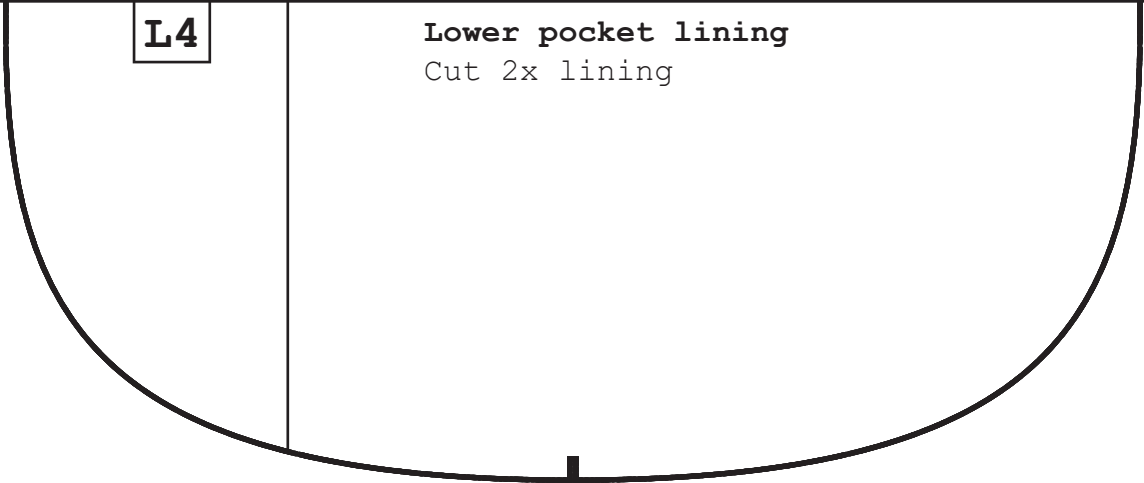

Grainline

[unfetteredpatterns.wordpress.com](http://unfetteredpatterns.wordpress.com)

Model #UP1040

Sizes XS-XL

Top pocket lining

Cut 2x lining

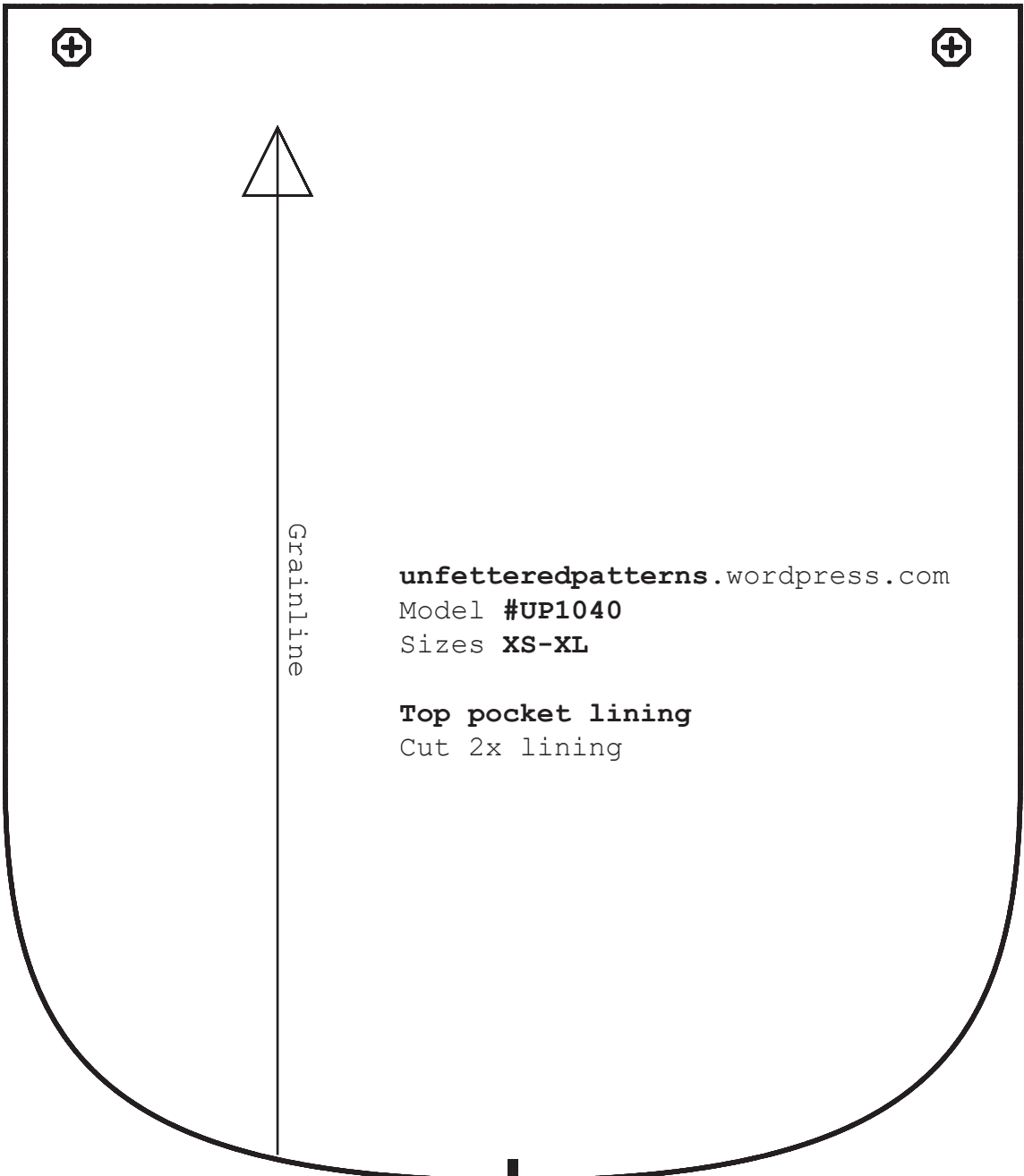

M3

